



REFRIGERATION AND
AIR CONDITIONING

Instructions

TQ



068R9648



RI1DA400

TQ ORIFICE No.

IP 55(IEC 529)

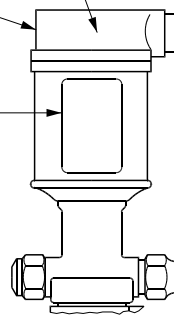

Pg 13,5

Danfoss
68F05.12

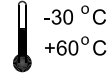

PS=22bar
MWP 320psig

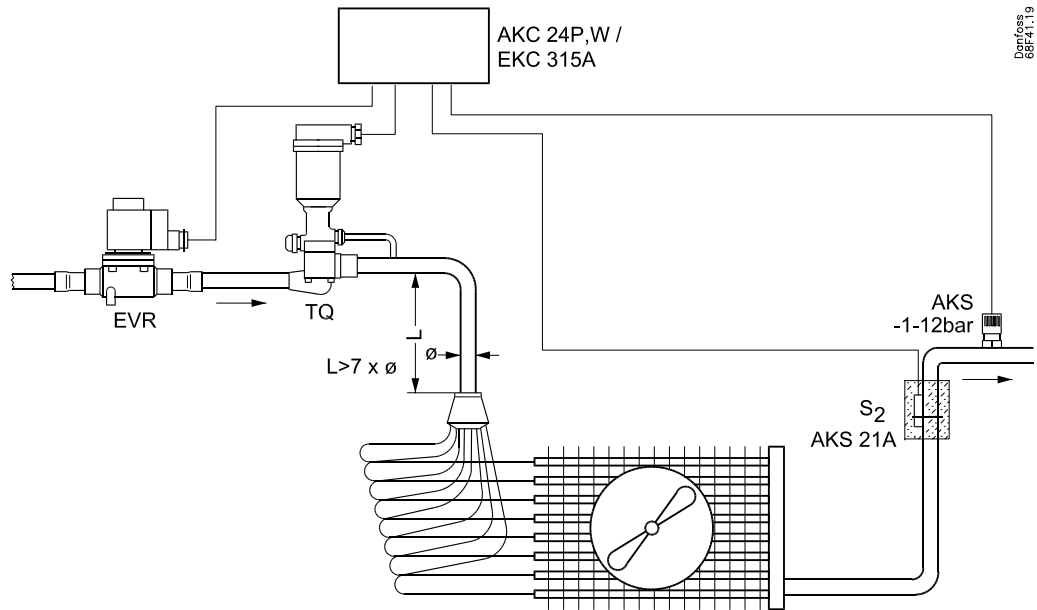

Danfoss
68F41.19

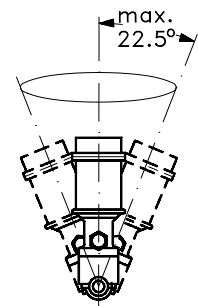
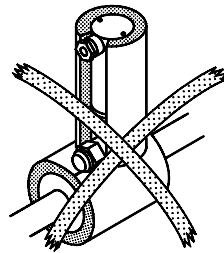
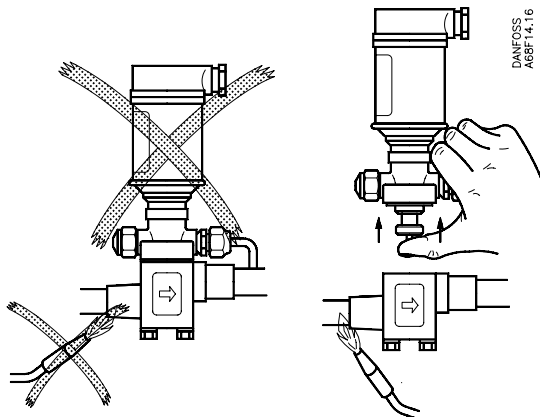

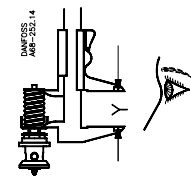

	Code no.	Type	Orifice	Y±0.5 mm	
				R22	
				TQ	PHTQ
	068F2041	TQ 5	No.1	26.5	27.5
	068F2042	TQ 5	No.2	26.5	
	068F2043	TQ 5	No.3	27.0	
<p>Bleed orifice</p>	068F2062	TQ 5	No.1	26.5	
	068F2063	TQ 5	No.2	26.5	
	068F2064	TQ 5	No.3	27.0	
	068F2033	TQ 20	No.1	33.0	
	068F2034	TQ 20	No.2	33.0	
	068F2035	TQ 20	No.3	33.0	
	068F2036	TQ 20	No.4	33.0	
	068F2037	TQ 20	No.5	33.0	
<p>Bleed orifice</p>	068F2055	TQ 20	No.1	33.0	
	068F2056	TQ 20	No.2	33.0	
	068F2057	TQ 20	No.3	33.0	
	068F2058	TQ 20	No.4	33.0	
	068F2059	TQ 20	No.5	33.0	
	068F2045	TQ 55	No.03	33.0	
	068F2046	TQ 55	No.05	33.0	
	068F2047	TQ 55	No.07	33.0	
	068F2048	TQ 55	No.1	33.0	
	068F2049	TQ 55	No.2	33.0	

