

009R9508



Temperature range:
-40°C → 150°C
(-40°F → 300°F)



PS/MWP = 45 bar (650 psig)

009R9508

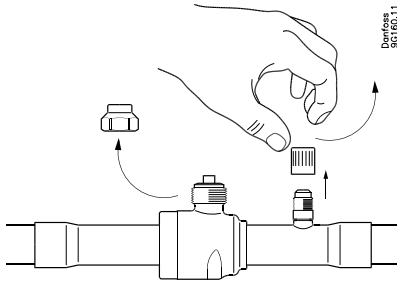

Remove cap and access cap (if present)

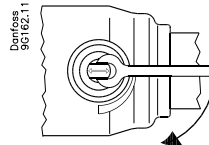

Open

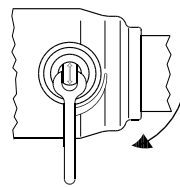

Closed



Change stem direction to open position

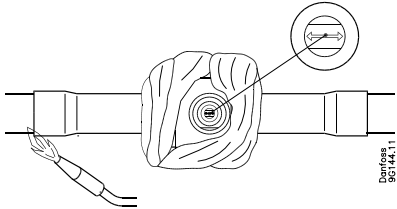

OPEN position

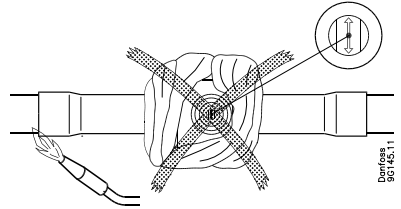

CLOSED position

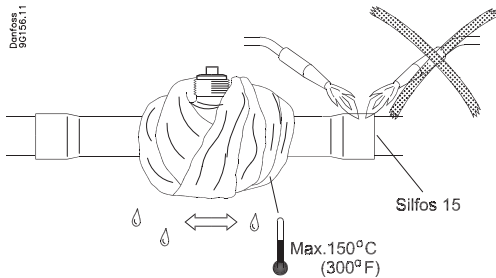

Install Schraeder valve
and cap (if present)

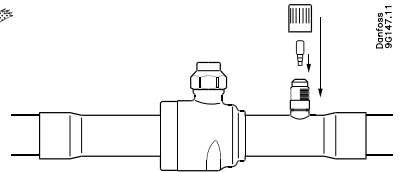

Open / close valves

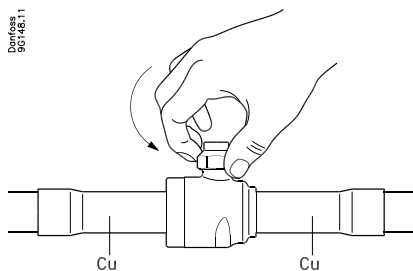

Remove cap

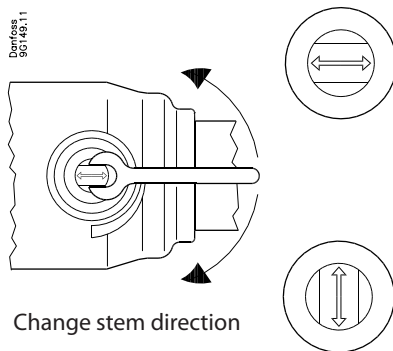

Change stem direction

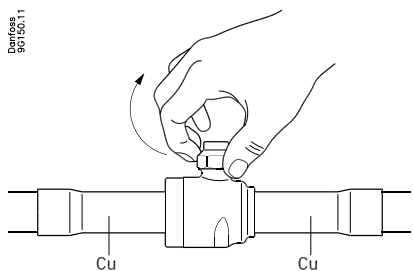

Hand tighten cap

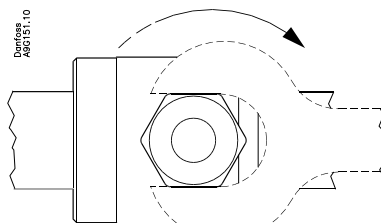

Tighten

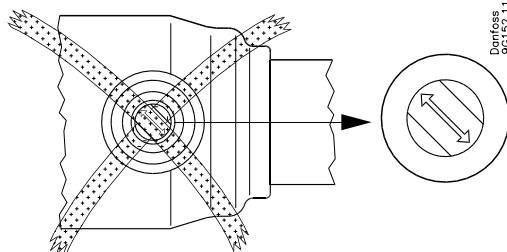

**Ball valve must always be in either
FULLY OPEN or
FULLY CLOSED position**