

DANFOSS
A68U21.10

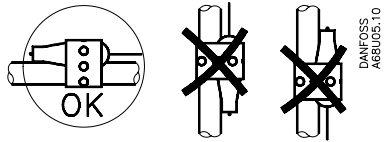

DANFOSS
A68U05.10

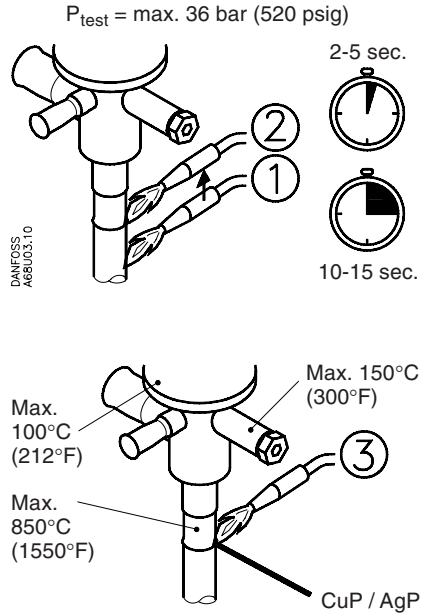
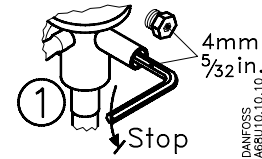
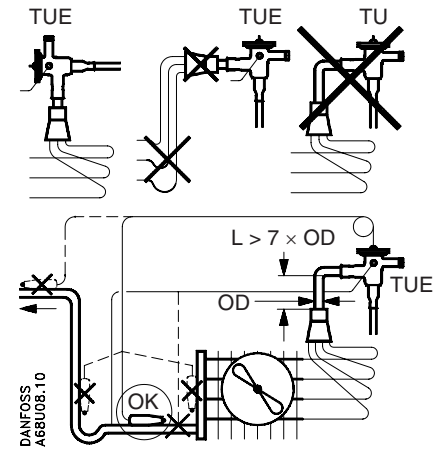
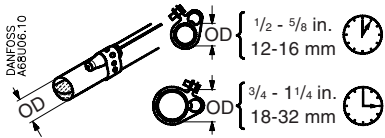

FS = Factory setting

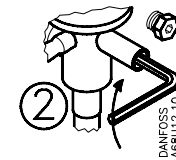

R 22: 6 - 7 × 360°
R 134a: 7 - 8 × 360°
R 404A: 8 - 9 × 360°

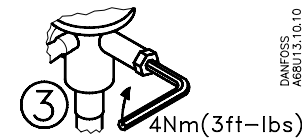

R 22	R 134a	R 404A	ΔFS 1 x
	N		2°C (3.6°F)
N	NM	N, B	2.5°C (4.5°F)
NM, B		NM	3°C (5.4°F)

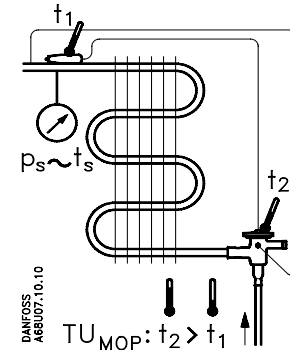

Superheat SH = $t_1 - t_s$

FS = Factory setting



N, B: 6°C (11°F)
N_{MOP}, NM: 5°C (9°F)
B_{MOP}: 5°C (9°F)